



# SYNERGY

INNOVATIVE DIVING EQUIPMENT TRADING LLC

INSPIRING • ENGINEERING • INNOVATION

UAE • UK • INDIA • AZERBAIJAN



## SY- ART SERIES - INDUSTRIAL APPLICATION ULTRASONIC CLEANER

### ▶ ALT - Industrial Ultrasonic Cleaner



- ✓ Internal Tank Material is SS316
- ✓ Microprocessor based Generator
- ✓ Adjustable Digital timer for ultrasonic process control
- ✓ Adjustable, Digital Temperature Controller
- ✓ Adjustable Ultrasonic Power Intensity, PLL Function / Sweeping Function
- ✓ Energy Saving Heat Insulation
- ✓ Water Trap in-Flow Lid Cover
- ✓ SS304 fittings with all units
- ✓ Power Input: 200 – 240 VAC / 3 Phase 415 V
- ✓ Inlet Valves & Drainage Materials are SS316

- Applications includes cleaning of
- a) Small industrial parts from optical parts
  - b) Small gear
  - c) Machined parts
  - d) PCBs
  - e) Bearings
  - f) Carburettor components
  - g) Surgical instruments, etc.



### Accessories (Optional)

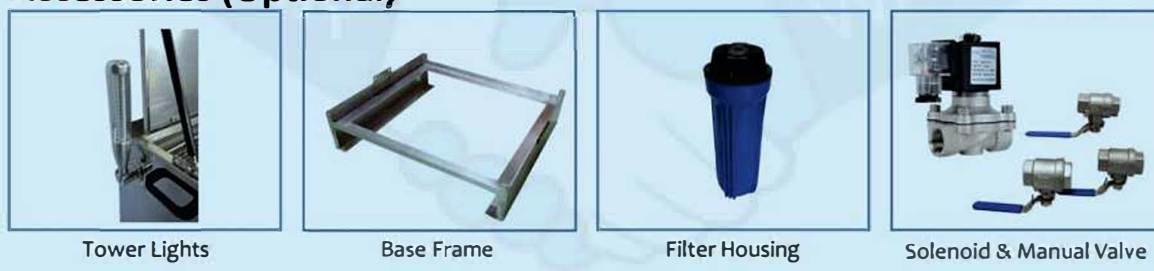

**The ART in Technology for Ultrasonic Cleaning Process**





# SY-ART SERIES - INDUSTRIAL APPLICATION ULTRASONIC CLEANER

## Control Panel Display

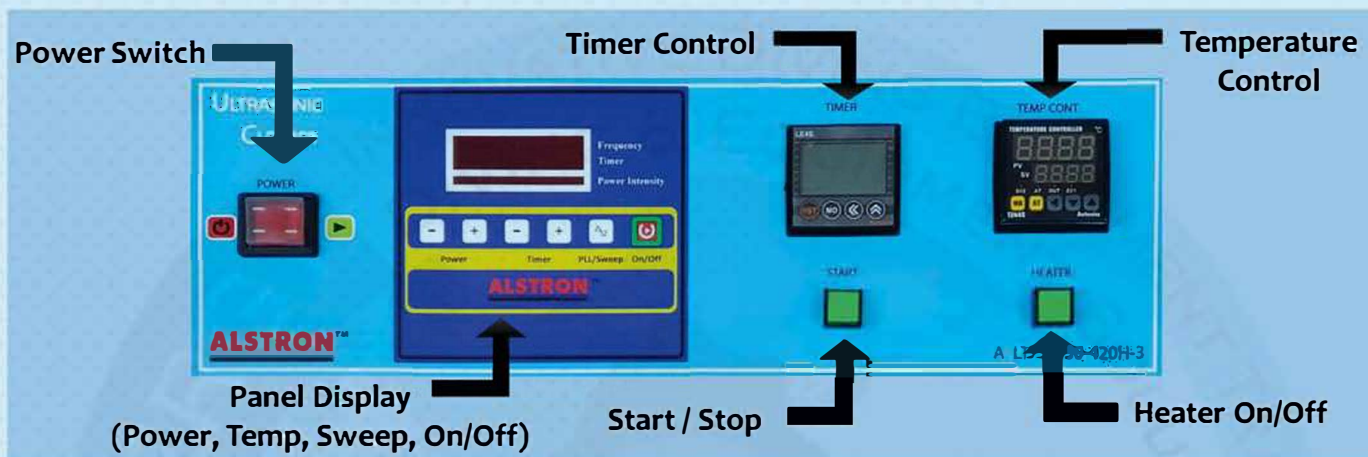

## 20 ~ 40 kHz Ultrasonic Cleaner Model Specifications

Application: Heavy Duty cleaning that requires deep cleaning on heavier particles on relatively robust materials or object.

20 kHz    28 kHz    33 kHz    40kHz

Power (Watts)	Volume (Litres)	20 kHz Model	28 kHz Model	33 kHz Model	40 kHz Model
300	12	ALT-20300-12H	ALT-28300-12H	ALT-33300-12H	ALT-40300-12H
600	24	ALT-20600-24H	ALT-28600-24H	ALT-33600-24H	ALT-40600-24H
800	40	ALT-20800-40H	ALT-28800-40H	ALT-33800-40H	ALT-40800-40H
1000	45	ALT-201000-45H	ALT-281000-45H	ALT-331000-45H	ALT-401000-45H
1200	72	ALT-201200-72H	ALT-281200-72H	ALT-331200-72H	ALT-401200-72H
1200	82	ALT-201200-82H*	ALT-281200-82H*	ALT-331200-82H*	ALT-401200-82H*
1500	90	ALT-201500-90H	ALT-281500-90H	ALT-331500-90H	ALT-401500-90H
		ALT-201500-90H-3	ALT-281500-90H-3	ALT-331500-90H-3	ALT-401500-90H-3
2000	140	ALT-202000-140H	ALT-282000-140H	ALT-332000-140H	ALT-402000-140H
		ALT-202000-140H-3	ALT-282000-140H-3	ALT-332000-140H-3	ALT-402000-140H-3
2400	245	ALT-202400-245H-3	ALT-282400-245H-3	ALT-332400-245H-3	ALT-402400-245H-3
2750	420	ALT-202750-420H-3**	ALT-282750-420H-3**	ALT-332750-420H-3**	ALT-402750-420H-3**

-3 : 3 Phase Power Supply

\* Optional Base Mount Stand (Size : 640 x 556 x 100 mm) (L x B x H)

\*\* Includes Tower Light with Timer alarm, Optional Base Mount Stand (Size : 1260 x 880 x 100 mm) (L x B x H)

# SY-ART SERIES - INDUSTRIAL APPLICATION ULTRASONIC CLEANER

## Inner & Outer Tank Specifications & Dimensions

Power (Watts)	Volume (Litres)	Inner Tank Size (L x B x H)(mm)	In/Out Valves	Outer Tank Size (L x B x H) (mm)	Heating Power (W)	Power Supply
300	12	305 x 250 x 170	Outlet	347 x 292 x 455	300	1 Phase 230 VAC 13 A Power Point
600	24	400 x 300 x 200		442 x 342 x 485	600	
800	40	400 x 400 x 250		442 x 422 x 535	900	
1000	45	500 x 300 x 300	Inlet & Outlet	542 x 400 x 586	1200	
1200	72	600 x 400 x 300		642 x 500 x 586	1500	
1200	82	550 x 300 x 500		622 x 540 x 908	1500	
1500	90	600 x 500 x 300	Inlet & Outlet	692 x 740 x 640	1500	1 Phase 230 VA 20 A Power Point
					2000	3 Phase 415 VAC
2000	140	700 x 500 x 400		1500	1 Phase 230 VAC 20 A Power Point	
				2000	3 Phase 415 VAC	
2400	245	700 x 700 x 500		792 x 955 x 873		4000
2750	420	1150 x 580 x 630		1244 x 865 x 1023		6000

Please refer to [page 37](#) for Accessories



ALT-xx300-12H ~ ALT-xx1200-72H



ALT-xx1200-82H ~ ALT-xx2750-420H



## SY-ART SERIES - INDUSTRIAL APPLICATION ULTRASONIC CLEANER

### 54 ~ 200 kHz Frequency Ultrasonic Cleaner Model Selections

Application:

Precision and gentle cleaning on more delicate parts and materials

54 kHz   68 kHz   80 kHz   100 kHz   124 kHz   135 kHz

Power (Watts)	Volume (Litres)	54 kHz Model	68 kHz Model	80 kHz Model	100 kHz Model	124 kHz Model	135 kHz Model
400	17	ALT-54400-17H	ALT-68400-17H	ALT-80400-17H	ALT-100400-17H	ALT-124400-17H	ALT-135400-17H
800	50	ALT-54800-50H	ALT-68800-50H	ALT-80800-50H	ALT-100800-50H	ALT-124800-50H	ALT-135800-50H
1000	69	ALT-541000-69H	ALT-681000-69H	ALT-801000-69H	ALT-1001000-69H	ALT-1241000-69H	ALT-1351000-69H
1200	82	ALT-541200-82H	ALT-681200-82H	ALT-801200-82H	ALT-1001200-82H	ALT-1241200-82H	ALT-1351200-82H
1500	140	ALT-541500-140H	ALT-681500-140H	ALT-801500-140H	ALT-1001500-140H	ALT-1241500-140H	ALT-1351500-140H
1500	140	ALT-541500-140H-3	ALT-681500-140H-3	ALT-801500-140H-3	ALT-1001500-140H-3	ALT-1241500-140H-3	ALT-1351500-140H-3
2700	270	ALT-542700-270H-3	ALT-682700-270H-3	ALT-802700-270H-3	ALT-1002700-270H-3	ALT-1242700-270H-3	ALT-1352700-270H-3

-3 : 3 Phase Power Supply

Remarks : Other supply voltage available upon request

### 170 ~ 200 kHz Frequency Ultrasonic Cleaner Model Selections

Application: Higher fine cleaning on dedicated parts and materials

170 kHz   200 kHz

Power (Watts)	Volume (Litres)	170 kHz Model	200 kHz Model
400	17	ALT-170400-17H	ALT-200400-17H
800	50	ALT-170800-50H	ALT-200800-50H
1000	69	ALT-1701000-69H	-

Remarks : Other supply voltage available upon request



# SY-ART SERIES - INDUSTRIAL APPLICATION ULTRASONIC CLEANER

## Inner & Outer Tank Specifications & Dimensions

Power (Watts)	Volume (Litres)	Inner Tank Size (L x B x H)(mm)	In/Out Valves	External Tank Size (L x B x H) (mm)	Heating Power (W)	Power Supply
400	17	350 x 250 x 200	Outlet	392 x 292 x 485	600	1 Phase 230 VAC 13 A Power Point
800	50	450 x 450 x 250		492 x 392 x 535	900	
1000	69	550 x 350 x 360		592 x 450 x 635	1200	
1200	82	550 x 300 x 500	Inlet & Outlet	622 x 540 x 908	1500	
1500	140	700 x 500 x 400		792 x 790 x 770	1500	
1500	140	700 x 500 x 400		792 x 790 x 770	2000	3 Phase 415 VAC
2700	270	900 x 600 x 500		1000 x 885 x 873	4000	

*Please refer to page 37 for Accessories*



Alstron Built in Generator Cleaning Tank (ALT series)

**Model Format :** ALT-331500-90H-3  
 ALT-FFPPPP-VVH-3  
**ALT – Series (Industrial Application Series)**  
 FF – Frequency in KHz      PPPP – Ultrasonic Power Rating  
 VV – Volume in Litres      -3 – 3 Phase Power Input

# SY-ART SERIES - INDUSTRIAL APPLICATION ULTRASONIC CLEANER

## ▶ ALT - 2inOne Industrial Ultrasonic Cleaner



Floor Standing 2inOne Ultrasonic Cleaning tank with Mounting Base



Floor Standing 2inOne Ultrasonic Cleaning tank with Castor wheel

- ✓ 2 Selectable Frequency within the same tank
- ✓ Internal Tank Material is SS316
- ✓ Microprocessor based Generator
- ✓ Adjustable Digital timer for ultrasonic duration control
- ✓ Adjustable, Digital Temperature Controller
- ✓ Adjustable Ultrasonic Power Intensity, Sweeping Function
- ✓ Water flow inward Lid Cover
- ✓ SS304 fittings with all units
- ✓ Power Input: 200 – 240 VAC /3 Phase 415 V
- ✓ Inlet Valves & Drainage Materials are SS316



Inlet | Outlet



Spring Catch Power Socket



Heat Loss Prevention Insulation Material



Float Switch – Low Water Level Protection



Gas Spring Assisted Cover



Splash Proof Cover - Control Panel Protection



Conceal Immersion Heater with Float Switch



Water inlet with Inlet valve



# SY-ART SERIES - INDUSTRIAL APPLICATION ULTRASONIC CLEANER

## 25/45 ~ 40/100 kHz Ultrasonic Cleaner Model Specifications

Application :

Gives you the flexibility to clean heavier contaminant and precision cleaning with a single tank including heater and timer and ultrasonic generator.

25/45 kHz    40/80 kHz    40/100 kHz

Power (Watts)	Volume (Litres)	24/45 kHz Model	40/80 kHz Model	40/100 kHz Model
400	17	ALT-2545-400-17H	ALT-4080-400-17H	ALT-40100-400-17H
800	50	ALT-2545-800-50H	ALT-4080-800-50H	ALT-40100-800-50H
1000	68	ALT-2545-1000-68H	ALT-4080-1000-68H	ALT-40100-1000-68H
1200	82	ALT-2545-1200-82H	ALT-4080-1200-82H	ALT-40100-1200-82H
1500	140	ALT-2545-1500-140H	ALT-4080-1500-140H	ALT-40100-1500-140H
1500	140	ALT-2545-1500-140H-3	ALT-4080-1500-140H-3	ALT-40100-1500-140H-3
2700	270	ALT-2545-2700-270H-3	ALT-4080-2700-270H-3	ALT-40100-2700-270H-3

Please refer to [page 37](#) for Accessories

## Inner & Outer Tank Specifications & Dimensions

Power (Watts)	Volume (Litres)	Inner Tank Size (L x B x H)(mm)	In/Out Valves	External Tank Size (L x B x H) (mm)	Heating Power (W)	Power Supply
400	17	350 x 250 x 200	Outlet	392 x 292 x 485	600	1 Phase 230 VAC
800	50	450 x 450 x 250		492 x 392 x 535	900	
1000	68	550 x 350 x 350	Inlet & Outlet	592 x 450 x 635	1200	
1200	82	550 x 300 x 500		622 x 540 x 908	1500	
1500	140	700 x 500 x 400		792 x 790 x 770	1500	
1500	140	700 x 500 x 400		792 x 790 x 770	2000	
2700	270	900 x 600 x 500	1000 x 885 x 873	4000	3 Phase 415 VAC	



2inOne Series  
ALT-xxxx400-17H ~ ALT-xxxx1000-68H



2inOne Series Floor Standing  
ALT-xxxx1200-82H ~ ALT-xxxx2700-270H

# SY-ART SERIES - INDUSTRIAL APPLICATION ULTRASONIC CLEANER



- ✓ Separated Tank offers deeper internal tank for more cleaning capacity
- ✓ Internal Tank Material is SS316 & External Tank Material is SS304 constructions
- ✓ Microprocessor based Generator
- ✓ Adjustable, Digital timer for ultrasonic duration control
- ✓ Optional adjustable, Digital Temperature Controller
- ✓ Adjustable Ultrasonic Power Intensity, Sweeping function
- ✓ Inlet Valves & Drainage Materials are SS316
- ✓ Power Input: 200 – 240 VAC / 3 Phase 415 V
- ✓ Used in Flammable/Volatile Liquids Applications with Separate Generator unit for Safety

Applications include

- a) Optical parts
- b) Small gears
- c) Degreasing machined parts,
- d) PCBs flux
- e) Bearings
- f) Preclean prior to coating and plating application,
- g) 3D printers components
- h) Surgical instruments etc.



Inlet | Outlet



Spring Catch Power Socket



Heat Loss Prevention Insulation Material



Standalone Generator Set



Gas Spring Assisted Cover for 1500W & above



With/without Heater



Water inlet with inlet valve



Ultrasonic Multi Direction (Single/Dual/3-Directional) Cleaning System Option



# SY-ART SERIES - INDUSTRIAL APPLICATION ULTRASONIC CLEANER

## 20 ~ 40 kHz Ultrasonic Cleaner Model Specifications

20 kHz   28 kHz   33 kHz   40 kHz

Power (Watts)	Volume (Litres)	20 kHz Model	28 kHz Model	33 kHz Model	40 kHz Model
400	15	AST-20400-15H	AST-28400-15H	AST-33400-15H	AST-40400-15H
600	38	AST-20600-38H	AST-28600-38H	AST-33600-38H	AST-40600-38H
1000	80	AST-201000-80H	AST-281000-80H	AST-331000-80H	AST-401000-80H
1200	96	AST-201200-96H	AST-281200-96H	AST-331200-96H	AST-401200-96H
1500	130	AST-201500-130H	AST-281500-130H	AST-331500-130H	AST-401500-130H
		AST-201500-130H-3	AST-281500-130H-3	AST-331500-130H-3	AST-401500-130H-3
2000	175	AST-202000-175H-3	AST-282000-175H-3	AST-332000-175H-3	AST-402000-175H-3
2800	284	AST-202800-284H-3	AST-282800-284H-3	AST-332800-284H-3	AST-402800-284H-3
2700	306	AST-202700-306H-3	AST-282700-306H-3	AST-332700-306H-3	AST-402700-306H-3
<b>3 Directional Wave Ultrasonic Cleaners</b>					
1300	56	AST-201300-56H	AST-281300-56H	AST-331300-56H	AST-401300-56H
1800	88	AST-201800-88H	AST-281800-88H	AST-331800-88H	AST-401800-88H
2400	92	AST-202400-92H	AST-282400-92H	AST-332400-92H	AST-402400-92H
<i>Please refer to page 37 for Accessories</i>					



AST Series Cleaning Tank

# SY-ART SERIES - INDUSTRIAL APPLICATION ULTRASONIC CLEANER

## Inner & Outer Tank Specifications & Dimensions

Power (Watts)	Volume (Litres)	Inner Tank Size (L x B x H)(mm)	In/Out Valves	External Tank Size (L x B x H) (mm)	Heating Power (W)	Power Supply
400	15	300 x 250 x 200	Outlet	342 x 292 x 320	300	1 Phase 230 VAC
600	38	450 x 300 x 280		492 x 342 x 400	600	
1000	80	500 x 400 x 400	Inlet & Outlet	542 x 442 x 520	900	
1200	96	600 x 400 x 400		642 x 442 x 520	1200	
1500	130	660 x 570 x 350		760 x 670 x 470	1200	1 Phase 230 VAC 3 Phase 415 VAC
2000	175	700 x 500 x 500		800 x 600 x 700	2000	3 Phase 415 VAC
2800	284	700 x 700 x 580		800 x 835 x 700	4000	
2700	306	850 x 600 x 600		950 x 735 x 720	4000	
<b>3 Directional Wave Ultrasonic Cleaners</b>						
1300	56	500 x 250 x 450	Inlet & Outlet	542 x 442 x 520	1200	1 Phase 230 VAC
1800	88	550 x 400 x 400		750 x 500 x 520	1500	
2400	92	350 x 350 x 750		550 x 550 x 850	3000	3 Phase 415 VAC
Please refer to <a href="#">page 37</a> for Accessories						



Separated Tank With Generator (AST series)



3 Directional Wave Ultrasonic Cleaner



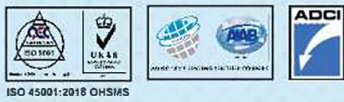

## SY-ART SERIES - INDUSTRIAL APPLICATION ULTRASONIC CLEANER

### 50 ~ 135 kHz Ultrasonic Cleaner Model Specifications

50 kHz   68 kHz   80 kHz   124 kHz   135 kHz

Power (Watts)	Volume (Litres)	50 kHz Model	68 kHz Model	80 kHz Model	124 kHz Model	135 kHz Model
300	15	AST-50400-15H	AST-68400-15H	AST-80400-15H	AST-124400-15H	AST-135400-15H
600	38	AST-50600-38H	AST-68600-38H	AST-80600-38H	AST-124600-38H	AST-135600-38H
1000	80	AST-501000-80H	AST-681000-80H	AST-801000-80H	AST-1241000-80H	AST-1351000-80H
1200	96	AST-501200-96H	AST-681200-96H	AST-801200-96H	AST-1241200-96H	AST-1351200-96H
1500	130	AST-501500-130H-3	AST-681500-130H-3	AST-801500-130H-3	AST-1241500-130H-3	AST-1351500-130H-3
2700	306	AST-502000-306H-3	AST-682000-306H-3	AST-802000-306H-3	AST-1242000-306H-3	AST-1352000-306H-3

-3 : 3 Phase Power Supply

Please refer to [page 37](#) for Accessories

### 170 ~ 200 kHz Ultrasonic Cleaner Model Specifications

170 kHz   200 kHz

Power (Watts)	Volume (Litres)	170 kHz Model	200 kHz Model
300	15	AST-170400-15H	AST-200400-15H
600	38	AST-170600-38H	AST-200600-38H
1000	80	AST-1701000-80H	-

Please refer to [page 37](#) for Accessories

# SY-ART SERIES - INDUSTRIAL APPLICATION ULTRASONIC CLEANER

## Inner & Outer Tank Specifications & Dimensions

Power (Watts)	Volume (Litres)	Inner Tank Size (L x B x H)(mm)	In/Out Valves	External Tank Size (L x B x H) (mm)	Heating Power (W)	Power Supply
300	15	300 x 250 x 200	Outlet	342 x 292 x 320	Optional	1 Phase 230 VAC
600	38	450 x 300 x 280		492 x 342 x 400		
1000	80	500 x 400 x 400	Inlet & Outlet	542 x 442 x 520	Optional / 900	
1200	96	600 x 400 x 400		642 x 442 x 520	Optional / 1200	
1500	130	660 x 570 x 350		760 x 705 x 470	2000	3 Phase 415 VAC
2700	306	850 x 600 x 600		950 x 735 x 875	4000	



AST Series Cleaning Tank with External Generator

**Model Format :** ALT-331500-90H-3  
AST-FFPPPP-VVH-3

**AST – Series (AST – Separate Tank)**  
**FF – Frequency in KHz**                      **PPPP – Ultrasonic Power Rating**  
**VV – Volume in Litres**                      **-3 – 3 Phase Power Input**



## SY-ART SERIES - INDUSTRIAL APPLICATION ULTRASONIC CLEANER

### ▶ AST – 2inOne Separate Tank Ultrasonic Cleaner



- ✓ Separated Tank offers deeper internal tank for more cleaning capacity
- ✓ Internal Tank Material is SS316 & External Tank Material is SS304 constructions
- ✓ Microprocessor based Generator
- ✓ Adjustable, Digital timer for ultrasonic duration control
- ✓ Optional adjustable, Digital Temperature Controller
- ✓ Adjustable Ultrasonic Power Intensity, Sweeping function
- ✓ Inlet Valves & Drainage Materials are SS316
- ✓ Power Input: 200 – 240 VAC / 3 Phase 415 V
- ✓ Used in Flammable/Volatile Liquids Applications with Separate Generator unit for Safety



Inlet | Outlet



Spring Catch Power Socket



Heat Loss Prevention  
Insulation Material



Standalone  
Generator Set



Gas Spring Assisted Cover  
for 1500W & above



With/without Heater



Water Inlet with  
Inlet Valve





# SY-ART SERIES - INDUSTRIAL APPLICATION ULTRASONIC CLEANER

## Basket for ALT Tank

✓ Heavy Duty SS316 Basket

Basket for ALT Tank	Model	Teflon Coated Model	Grid Size (mm)	Dimension Size (L x B x H)(mm)	Material	Suitable for ALT Series Tank Vol (L)
	ABK-ALT-12-00	ABK-ALT-12-00P	25 x 25	285 x 230 x 100	SS316	12
	ABK-ALT-17-00	ABK-ALT-17-00P		330 x 230 x 130		17
	ABK-ALT-24-00	ABK-ALT-24-00P		380 x 280 x 130		24
	ABK-ALT-40-00	ABK-ALT-40-00P		380x 380 x 180		40
	ABK-ALT-45-00	ABK-ALT-45-00P		480 x 280 x 230		45
	ABK-ALT-50-00	ABK-ALT-50-00P		430 x 430 x 180		50
	ABK-ALT-69-00	ABK-ALT-69-00P		530 x 330 x 290		69
	ABK-ALT-72-00	ABK-ALT-72-00P		580 x 380 x 230		72
	ABK-ALT-82-00	ABK-ALT-82-00P		530 x 280 x 425		82
	ABK-ALT-90-00	ABK-ALT-90-00P		580 x 580 x 230		90
	ABK-ALT-140-00	ABK-ALT-140-00P		680 x 480 x 330		140
	ABK-ALT-245-00	ABK-ALT-245-00P		680 x 480 x 330		245
	ABK-ALT-270-00	ABK-ALT-270-00P		870 x 570 x 430		270
	ABK-ALT-420-00	ABK-ALT-420-00P		1126 x 560 x 550		420
Available Model Options for Grid size type 01 (10 x 10) (Eg. ABK-ALT-12-01 or ABK-ALT-12-01P) Grid size 25x25 (mm) - 00, 5 x 5 (mm) - 005, 10x 10 (mm) - 01						

## Inner Container for ALT Tank

Inner Container	Model	Dimension Size (L x B x H)(mm)	Material	Suitable for ALT Series Tank Size (L)
	ABK-ALT-12-XX	240 x 200 x 120	SS316	12
	ABK-ALT-24-XX	340 x 250 x 150		24
	ABK-ALT-40-XX	340 x 340 x 200		40
	ABK-ALT-45-XX	440 x 240 x 250		45
	ABK-ALT-72-XX	520 x 340 x 250		72
	ABK-ALT-82-XX	470x 240 x 350		82

# SY-ART SERIES - INDUSTRIAL APPLICATION ULTRASONIC CLEANER

## Basket for Ultrasonic Cleaner

### Mesh Tray for ALT Tank

✓ Use when you need the entire width space of the Cleaner Tank by placing Mesh Tray on the Tank Basket Brackets

Mesh Tray	Model	Dimension Size (L x B)(mm)	Rod Size (mm)	Material	Suitable for ALT Series Tank Size (L)
	ABK-ALT-12-02	295 x 240	5	SS304	12
	ABK-ALT-17-02	340 x 240			17
	ABK-ALT-24-02	390 x 290			24
	ABK-ALT-40-02	390 x 390	6		40
	ABK-ALT-45-02	490 x 290			45
	ABK-ALT-50-02	440 x 440			50
	ABK-ALT-69-02	540 x 340	8		69
	ABK-ALT-72-02	590 x 390			72
	ABK-ALT-82-02	540 x 290			82
	ABK-ALT-90-02	590 x 490	10		90
	ABK-ALT-140-02	685 x 485			140
	ABK-ALT-245-02	685 x 685			245
	ABK-ALT-270-02	885 x 585			270
	ABK-ALT-420-02	1130 x 560			420

### Customised Basket on Request



Heavy Duty Basket



Internal Basket



Partition Basket

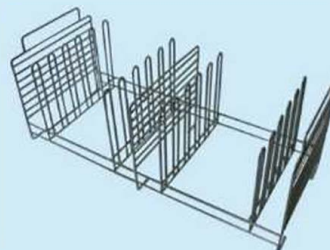



## SY-ART SERIES - INDUSTRIAL APPLICATION ULTRASONIC CLEANER

### Basket for AST Tank

✓ Heavy Duty SS316 Basket

Basket for AST Tank	Model	Teflon Coated Model	Grid Size (mm)	Dimension Size (L x B x H)(mm)	Material	Suitable for AST Series Tank Size (L)
	ABK-AST-15-00	ABK-AST-15-00P	25 x 25	280 x 230 x 130	SS316	15
	ABK-AST-38-00	ABK-AST-38-00P		430 x 280 x 210		38
	ABK-AST-56-00	ABK-AST-56-00P		480 x 230 x 380		56
	ABK-AST-80-00	ABK-AST-80-00P		480 x 380 x 330		80
	ABK-AST-88-00	ABK-AST-88-00P		530 x 380 x 330		88
	ABK-AST-92-00	ABK-AST-92-00P		330 x 330 x 650		92
	ABK-AST-96-00	ABK-AST-96-00P		580 x 380 x 330		96
	ABK-AST-130-00	ABK-AST-130-00P		640 x 550 x 280		130
	ABK-AST-175-00	ABK-AST-175-00P		680 x 480 x 430		175
	ABK-AST-284-00	ABK-AST-284-00P		670 x 670 x 500		284
	ABK-AST-306-00	ABK-AST-306-00P		820 x 570 x 520		306
Available Model Options for Grid size type 01 (10 x 10) (Eg. ABK-AST-15-01 or ABK-AST-15-01P) Grid size 25x25 (mm) - 00, 5 x 5 (mm) - 005, 10x 10 (mm) - 01						

### Inner Container for AST Tank

Inner Container	Model	Dimension Size (L x B x H)(mm)	Material	Suitable for AST Series Tank Size (L)
	ABK-AST-15-XX	240 x 200 x 150	SS316	15
	ABK-AST-38-XX	370 x 250 x 220		38
	ABK-AST-56-XX	440 x 200 x 350		56
	ABK-AST-80-XX	420 x 340 x 300		80
	ABK-AST-88-XX	470 x 340 x 300		88
	ABK-AT-130-XX	580 x 510 x 250		130

# SY-ART SERIES - INDUSTRIAL APPLICATION ULTRASONIC CLEANER

## Mesh Tray for AST Tank

✓ Use when you need the entire width space of the Cleaner Tank by placing Mesh Tray on the Tank Basket Brackets

Mesh Tray	Model	Dimension Size (L x B)(mm)	Rod Size (mm)	Material	Suitable for AST Series Tank Size (L)
	ABK-AST-15-01	290 x 240	5	SS316	15
	ABK-AST-38-01	440 x 290			38
	ABK-AST-56-01	490 x 240			56
	ABK-AST-80-01	490 x 390			80
	ABK-AST-88-01	540 x 390	6		88
	ABK-AST-92-01	340 x 340			92
	ABK-AST-96-01	590 x 390			96
	ABK-AST-130-01	650 x 560			130
	ABK-AST-175-01	685 x 485	8		175
	ABK-AST-284-01	685 x 685			284
	ABK-AST-306-01	835 x 585	10		306

## Customised Basket on Request



Heavy Duty Basket



Internal Basket



Partition Basket

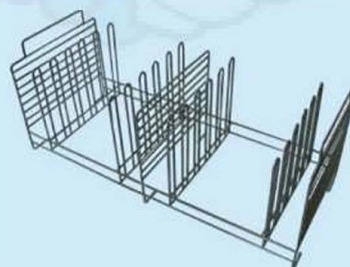



## SY-ART SERIES - INDUSTRIAL APPLICATION ULTRASONIC CLEANER

### ► AIM – Immersible Ultrasonic Cleaner



Ultrasonic Immersible with Generator

- ✓ SS316L Stainless Steel Material
- ✓ Four (4) Mounting Options
- ✓ Thin Profile 70 – 85 mm
- ✓ Available in 600, 1000, 1200, 2000 W output
- ✓ Standard sizes as well as custom sizes available

### ► ATB – Tubular Ultrasonic Cleaner



Tubular Ultrasonic



Cascading Sonotrode

- ✓ 360 degree radiating on the circular tube providing omnidirectional cleaning energy with minimal dead zone
- ✓ High Power and High Efficiency
- ✓ Not affected by depths of liquid.
- ✓ Uniformity of oscillation from external tubing

## SY-ART SERIES - INDUSTRIAL APPLICATION ULTRASONIC CLEANER

### AIM – Immersible Ultrasonic Cleaner

#### ► Riser Type

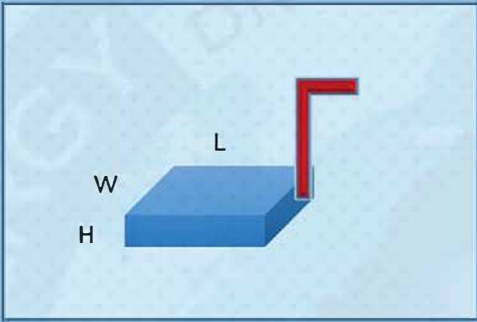

Riser Type 01  
Pipe On Horizontal Immersible



Riser Type 02  
Flexible Hose on Horizontal Immersible

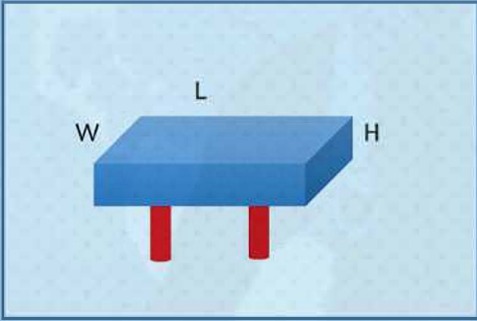

Riser Type 03  
Bulk Head on Horizontal Immersible

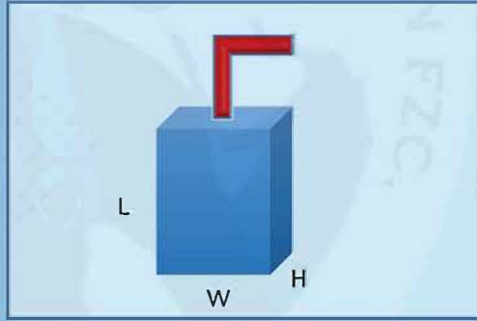

Riser Type 04  
Pipe On Vertical Immersible

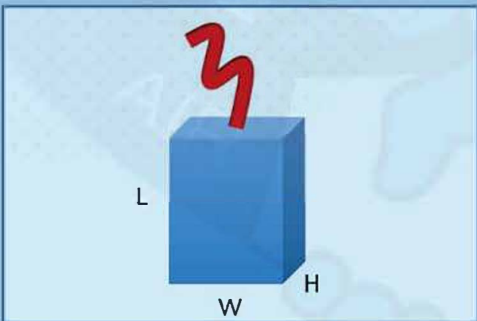

Riser Type 05  
Flexible Hose On vertical Immersible

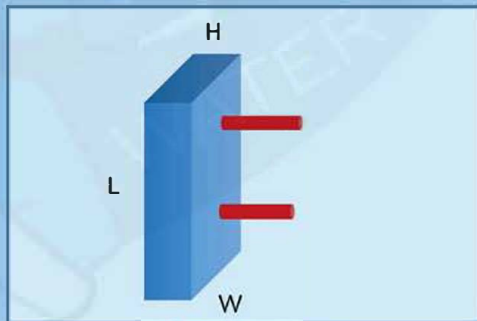

Riser Type 06  
Bulk Head on Vertical Immersible



Immersible Piping

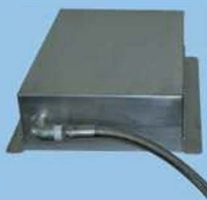

Flexible Hose

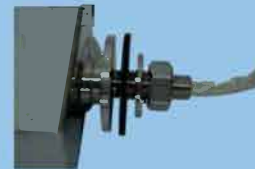

Bulk Head





## SY-ART SERIES - INDUSTRIAL APPLICATION ULTRASONIC CLEANER

### AIM Series Ultrasonic Immersible

#### 24 ~ 40 kHz Ultrasonic Immersible Model Specifications

20 kHz    28 kHz    33 kHz    40 kHz

Power (Watts)	20 kHz Model	28 kHz Model	33 kHz Model	40 kHz Model
300	AIM-20300-LLLWWW-TT	AIM-28300-LLLWWW-TT	AIM-33300-LLLWWW-TT	AIM-40300-LLLWWW-TT
600	AIM-20600-LLLWWW-TT	AIM-28600-LLLWWW-TT	AIM-33600-LLLWWW-TT	AIM-40600-LLLWWW-TT
800	AIM-20800-LLLWWW-TT	AIM-28800-LLLWWW-TT	AIM-33800-LLLWWW-TT	AIM-40800-LLLWWW-TT
1000	AIM-201000-LLLWWW-TT	AIM-281000-LLLWWW-TT	AIM-331000-LLLWWW-TT	AIM-401000-LLLWWW-TT
1200	AIM-201200-LLLWWW-TT	AIM-281200-LLLWWW-TT	AIM-331200-LLLWWW-TT	AIM-401200-LLLWWW-TT
1500	AIM-201500-LLLWWW-TT	AIM-281500-LLLWWW-TT	AIM-331500-LLLWWW-TT	AIM-401500-LLLWWW-TT
2000	AIM-202000-LLLWWW-TT	AIM-282000-LLLWWW-TT	AIM-332000-LLLWWW-TT	AIM-402000-LLLWWW-TT
2400	AIM-202400-LLLWWW-TT	AIM-282400-LLLWWW-TT	AIM-332400-LLLWWW-TT	AIM-402400-LLLWWW-TT

(Eg. AIM-20300-028020-01, for 028 cm Length, 020 cm width, 01 – Raiser Type 01)

**LLLWWW-TT** – Refer to [page 21](#) for the config parameters

Please refer to [page 37](#) for Accessories

### Generators

Power (Watts)	20 kHz Generator Model	28 kHz Generator Model	33 kHz Generator Model	40 kHz Generator Model
300	AHG-20300	AHG-28300	AHG-33300	AHG-40300
600	AHG-20600	AHG-28600	AHG-33600	AHG-40600
800	AHG-20800	AHG-28800	AHG-33800	AHG-40800
1000	AHG-201000	AHG-281000	AHG-331000	AHG-401000
1200	AHG-201200	AHG-281200	AHG-331200	AHG-401200
1500	AHG-201500	AHG-281500	AHG-331500	AHG-401500
2000	AHG-202000	AHG-282000	AHG-332000	AHG-402000
2400	AHG-202400	AHG-282400	AHG-332400	AHG-402400

# SY-ART SERIES - INDUSTRIAL APPLICATION ULTRASONIC CLEANER

## AIM Series Ultrasonic Immersible

### Inner & Outer Immersible Specifications & Dimensions

Power (Watts)	immersible Size (L x B x H)(mm)	Power Supply
300	280 x 200 x 75	1 phase 230Vac
600	380 x 300 x 75	
800	360 x 330 x 75	
1000	470 x 280 x 75	
1200	560 x 370 x 75	
1500	540 x 450 x 75	
2000	750 x 450 x 75	
2400	770 x 580 x 75	



Immersible unit with matching Generator

<b>Model Format :</b>	AIM-33300-028020-01 AIM-FFPPPP-LLLWWW-TT
<b>AIM – Alstron Immersible Series</b>	
<b>FF – Frequency (20, 28, 40 KHz)</b>	<b>PPPP – Ultrasonic Power Rating</b>
<b>Specification Config</b>	
<b>LLL – Length (cm) (eg. 028 = 28 cm)</b>	<b>WWW – Width (cm) (eg. 020 = 20 cm)</b>
<b>TT – Riser Type (refer to page 28)</b>	





## SY-ART SERIES - INDUSTRIAL APPLICATION ULTRASONIC CLEANER

### AIM Series Ultrasonic Immersible

#### 50 ~ 135 kHz Ultrasonic Immersible Model Specifications

50 kHz   68 kHz   80 kHz   100 kHz   124 kHz   135 kHz

Power (Watts)	50 kHz Model	68 kHz Model	80 kHz Model	100 kHz Model	124 kHz Model	135 kHz Model
300	AIM-50300-LLLWWW-TT	AIM-68300-LLLWWW-TT	AIM-80300-LLLWWW-TT	AIM-100300-LLLWWW-TT	AIM-124300-LLLWWW-TT	AIM-135300-LLLWWW-TT
600	AIM-50600-LLLWWW-TT	AIM-68600-LLLWWW-TT	AIM-80600-LLLWWW-TT	AIM-100600-LLLWWW-TT	AIM-124600-LLLWWW-TT	AIM-135600-LLLWWW-TT
800	AIM-50800-LLLWWW-TT	AIM-68800-LLLWWW-TT	AIM-80800-LLLWWW-TT	AIM-100800-LLLWWW-TT	AIM-124800-LLLWWW-TT	AIM-135800-LLLWWW-TT
1000	AIM-501000-LLLWWW-TT	AIM-681000-LLLWWW-TT	AIM-801000-LLLWWW-TT	AIM-1001000-LLLWWW-TT	AIM-1241000-LLLWWW-TT	AIM-1351000-LLLWWW-TT
1200	AIM-501200-LLLWWW-TT	AIM-681200-LLLWWW-TT	AIM-801200-LLLWWW-TT	AIM-1001200-LLLWWW-TT	AIM-1241200-LLLWWW-TT	AIM-1351200-LLLWWW-TT
1500	AIM-501500-LLLWWW-TT	AIM-681500-LLLWWW-TT	AIM-801500-LLLWWW-TT	AIM-1001500-LLLWWW-TT	AIM-1241500-LLLWWW-TT	AIM-1351500-LLLWWW-TT

(Eg. AIM-50300-028020-01, for 028 cm Length, 020 cm width, 01 – Raiser Type 01)  
 LLLWWW-TT – Refer to [page 21](#) for the config parameters  
 Please refer to [page 37](#) for Accessories

#### 170 ~ 200 kHz Ultrasonic Immersible Model Specifications

170 kHz   200 kHz

Power (Watts)	170 kHz Model	200 kHz Model
300	AIM-170300-LLLWWW-TT	AIM-200300-LLLWWW-TT
600	AIM-170600-LLLWWW-TT	AIM-200600-LLLWWW-TT
800	AIM-170800-LLLWWW-TT	AIM-200800-LLLWWW-TT
1000	AIM-1701000-LLLWWW-TT	-

(Eg. AIM-170300-028020-01, for 028 cm Length, 020 cm width, 01 – Raiser Type 01)  
 LLLWWW-TT – Refer to [page 21](#) for the config parameters  
 Please refer to [page 37](#) for Accessories



# SY-ART SERIES - INDUSTRIAL APPLICATION ULTRASONIC CLEANER

## AIM Series Ultrasonic Immersible

### Generator

Power (Watts)	50 kHz Model	68 kHz Model	80 kHz Model	100 kHz Model	124 kHz Model	135 kHz Model
300	AHG-50300	AHG-68300	AHG-80300	AHG-100300	AHG-124300	AHG-135300
600	AHG-50600	AHG-68600	AHG-80600	AHG-100600	AHG-124600	AHG-135600
800	AHG-50800	AHG-68800	AHG-80800	AHG-100800	AHG-124800	AHG-135800
1000	AHG-501000	AHG-681000	AHG-801000	AHG-1001000	AHG-1241000	AHG-1351000
1200	AHG-501200	AHG-681200	AHG-801200	AHG-1001200	AHG-1241200	AHG-1351200
1500	AHG-501500	AHG-681500	AHG-801500	AHG-1001500	AHG-1241500	AHG-1351500

Power (Watts)	170 kHz Model	200 kHz Model
300	AHG-170300	AHG-200300
600	AHG-170600	AHG-200600
800	AHG-170800	AHG-200800
1000	AHG-1701000	-

### Immersible Specifications & Dimensions

Power (Watts)	immersible Size (L x B x H)(mm)	Power Supply
300	280 x 200 x 75	1 phase 230 Vac
600	380 x 300 x 75	
800	360 x 330 x 75	
1000	470 x 280 x 75	
1200	560 x 370 x 75	
1500	540 x 450 x 75	



# SY-ART SERIES - INDUSTRIAL APPLICATION ULTRASONIC CLEANER

## AIM Series Ultrasonic Immersible

### 25/45 ~ 40/100 kHz Ultrasonic Immersible Model Specifications

25/45 kHz    40/80 kHz    40/100 kHz

Power (Watts)	24/45 kHz Model	40/80 kHz Model	40/100 kHz Model
300	AIM-2545-300-LLLWWW-TT	AIM-4080-300-LLLWWW-TT	AIM-40100-300-LLLWWW-TT
600	AIM-2545-600-LLLWWW-TT	AIM-4080-600-LLLWWW-TT	AIM-40100-600-LLLWWW-TT
800	AIM-2545-800-LLLWWW-TT	AIM-4080-800-LLLWWW-TT	AIM-40100-800-LLLWWW-TT
1000	AIM-2545-1000-LLLWWW-TT	AIM-4080-1000-LLLWWW-TT	AIM-40100-1000-LLLWWW-TT
1200	AIM-2545-1200-LLLWWW-TT	AIM-4080-1200-LLLWWW-TT	AIM-40100-1200-LLLWWW-TT
1500	AIM-2545-1500-LLLWWW-TT	AIM-4080-1500-LLLWWW-TT	AIM-40100-1500-LLLWWW-TT

(Eg. AIM-2545-300-028020-01, for 028 cm Length, 020 cm width, 01 – Raiser Type 01)  
**LLLWWW-TT** – Refer to [page 21](#) for the config parameters  
 Please refer to [page 37](#) for Accessories

### Generator

Power (Watts)	24/45 kHz Generator Model	40/80 kHz Generator Model	40/100 kHz Generator Model
300	AHG-2545-300	AHG-4080-300	AHG-40100-300
600	AHG-2545-600	AHG-4080-600	AHG-40100-600
800	AHG-2545-800	AHG-4080-800	AHG-40100-800
1000	AHG-2545-1000	AHG-4080-1000	AHG-40100-1000
1200	AHG-2545-1200	AHG-4080-1200	AHG-40100-1200
1500	AHG-2545-1500	AHG-4080-1500	AHG-40100-1500

### Immersible Specifications & Dimensions

Power (Watts)	Immersible Size (L x B x H)(mm)	Power Supply
300	280 x 200 x 75	1 phase 230 Vac
600	380 X 300 x 75	
800	360 x 330 x 75	
1000	470 x 280 x 75	
1200	560 x 370 x 75	
1500	540 x 450 x 75	

# SY-ART SERIES - INDUSTRIAL APPLICATION ULTRASONIC CLEANER

## Tubular Series

- ✓ SS316 Construction
- ✓ High Efficiency
- ✓ 360 degree radiating surface



26 kHz

Power (Watts)	Length (mm)	Tubular Probe Model with Generator	Tubular Probe Model	Frequency (kHz)	Diameter (mm)
500	270	ATB-AHG-26500-270	ATB-26500-270	26	73
1000	458	ATB-AHG-261000-458	ATB261000-458		
1100	624	ATB-AHG-261100-624	ATB-261100-624		
1200	790	ATB-AGH-261200-790	ATB-261200-790		
1300	957	ATB-AHG-261300-957	ATB-261300-957		
1500	1123	ATB-AHG-261500-1123	ATB-261500-1123		
2000	910	ATB-AHG-262000-910	ATB-262000-910		

## Cascading Ultrasonic Sonotrode

- ✓ Titanium alloy radiator provides high durability
- ✓ 360 degree radiating surface provides omnidirectional energy with minimum dead zone

20 kHz

Power (Watts)	Cascade Length (mm)	Sonotrode with Generator	Cascading Probe Model	Frequency (kHz)	A Length (mm)	Diameter (mm)
1000	210	ACS-AHG-201000-210	ACS-201000-210	20	570	53
1000	350	ACS-AHG-201000-350	ACS-201000-350		710	
1500	490	ACS-AHG-201500-490	ACS-201500-490		850	
2000	630	ACS-AHG-202000-630	ACS-202000-630		990	





**SY-ART SERIES - INDUSTRIAL APPLICATION ULTRASONIC CLEANER**

**ACP Circular Piping Cleaning System**

**Circular Piping Cleaning System**

- ✓ Clamp On transducers for pipe cleaning
- ✓ Non Intrusive on pipe cleaning

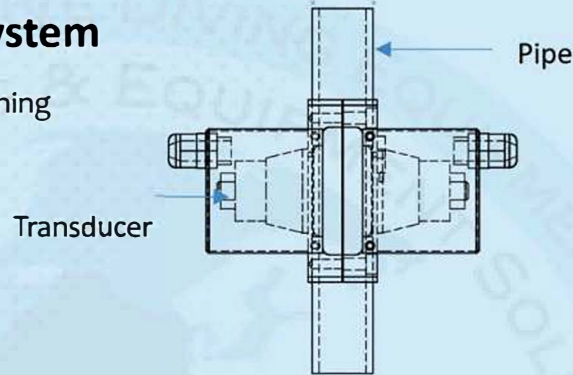

28 kHz

Power (W)	Frequency (kHz)	Pipe Size (1 inch)	Pipe Size (1.5 inch)	Pipe Size (2 inch)	Pipe Size (3 inch)
100	28	ACP-28100-10	ACP-28100-15	ACP-28100-20	ACP-28100-30
200	28	ACP-28200-10	ACP-28200-15	ACP-28200-20	ACP-28200-30
300	28	ACP-28300-10	ACP-28300-15	ACP-28300-20	ACP-28300-30

**Specifications & Dimensions**

Power (W)	Frequency (kHz)	Length (mm)	Choice of Generator
100	28	100	ACPG-28100 or ACPG-28100-T (Temp. Display) ACPG-28200 or ACPG-28200-T ACPG-28300 or ACPG-28300-T ACPG-28400 or ACPG-28400-T ACPG-28500 or ACPG-28500-T ACPG-28600 or ACPG-28600-T
200	28	200	
300	28	300	

**Model Format :** ACP-28100-10  
ACP-FFPPP-LL

ACP – Alstron Circular Piping Transducers Series  
 FF – Frequency (20, 28, 40 KHz)      PPP – Ultrasonic Power Rating  
 LLL – Pipe Size (eg. 10 = 1 inch)

# SY-ART SERIES - INDUSTRIAL APPLICATION ULTRASONIC CLEANER

## Generator

### ▶ Ultrasonic Generator



Ultrasonic Generator



Ultrasonic Generator with Temperature control

- ✓ Internal Tank Material is SS316
- ✓ Adjustable Digital timer for ultrasonic duration control
- ✓ Adjustable, Digital Temperature Controller
- ✓ Adjustable Ultrasonic Power Intensity
- ✓ Strong Holding handles
- ✓ Top Cover Material is SS304 included with all units
- ✓ Power Input: 200 – 240 VAC
- ✓ Drainage pipes Material is SS316 for on/off valves

Our Generator can be use for



Immersible Tank

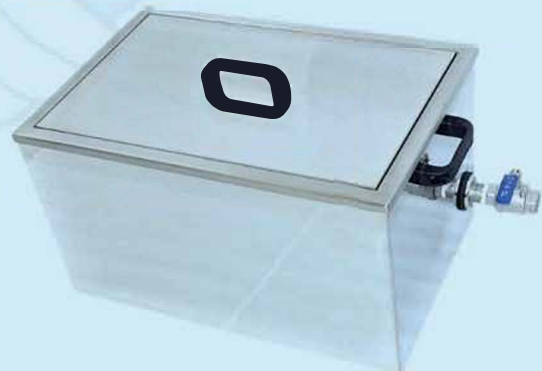

AST Tank





## SY-ART SERIES - INDUSTRIAL APPLICATION ULTRASONIC CLEANER

### 28 ~ 40 kHz Ultrasonic Generator Model Specifications

28 kHz   33 kHz   40 kHz

Power (Watts)	28 kHz Model	33 kHz Model	40 kHz Model	Temp Control
300	AHG-28300	AHG-33300	AHG-40300	No
	AHG-28300-H	AHG-33300-H	AHG-40300-H	PT100
600	AHG-28600	AHG-33600	AHG-40600	No
	AHG-28600-H	AHG-33600-H	AHG-40600-H	PT100
800	AHG-28800	AHG-33800	AHG-40800	No
	AHG-28800-H	AHG-33800-H	AHG-40800-H	PT100
1200	AHG-281200	AHG-331200	AHG-401200	No
	AHG-281200-H	AHG-331200-H	AHG-401200-H	PT100
1500	AHG-281500	AHG-331500	AHG-401500	No
	AHG-281500-H	AHG-331500-H	AHG-401500-H	PT100
2000	AHG-282000	AHG-332000	AHG-402000	No
	AHG-282000-H	AHG-332000-H	AHG-402000-H	PT100
2400	AHG-282400	AHG-332400	AHG-402400	No
	AHG-282400-H	AHG-332400-H	AHG-402400-H	PT100
2800	AHG-282800	AHG-332800	AHG-402800	No
	AHG-282800-H	AHG-332800-H	AHG-402800-H	PT100

Please refer to [page 37](#) for Accessories

### Specifications & Dimensions

Power (Watts)	Dimension Size (W x D x H) (mm)	Frequency Control	Power Intensity Control	Sweeping Function	Remote Contact / Voltage Control	Power Supply
300	300 x 360 x 150	Micro Processor Based	Yes	Yes	Yes	230 V 1 Phase
600						
800						
1200						
1500	355 x 390 x 145					
2000						
2400						
2800						

# SY-ART SERIES - INDUSTRIAL APPLICATION ULTRASONIC CLEANER

## Ultrasonic Generator

### 68 ~ 135 kHz Ultrasonic Generator Model Specifications

68 kHz    80 kHz    135 kHz

Power (Watts)	68 kHz Model	80 kHz Model	135 kHz Model
300	AHG-68300	AHG-80300	AHG-135300
600	AHG-68600	AHG-80600	AHG-135600
1000	AHG-681000	AHG-801000	AHG-1351000
1200	AHG-681200	AHG-801200	AHG-1351200
1500	AHG-681500	AHG-801500	

Please refer to [page 37](#) for Accessories

### Specifications & Dimensions

Power (Watts)	Dimension Size (W x D x H) (mm)	Frequency Control	Power Intensity Control	Sweeping Function	Remote Contact / Voltage Control	Temp Control	Power Supply
300	355 x 395 x 145	Micro Processor Based	Yes	Yes	Yes	No	230 V 1 Phase
600							
1000							
1200							
1500							





# SY-ART SERIES - INDUSTRIAL APPLICATION ULTRASONIC CLEANER

## Ultrasonic Generator

### 25/45 ~ 40/100 kHz Ultrasonic Generator Model Specifications

25/45 kHz    40/80 kHz    40/100 kHz

Power (Watts)	25/45 kHz Model	40/80 kHz Model	40/100 kHz Model
300	AHG-2545-300	AHG-4080-300	AHG-40100-300
600	AHG-2545-600	AHG-4080-600	AHG-40100-600
1000	AHG-2545-1000	AHG-4080-1000	AHG-40100-1000
1200	AHG-2545-1200	AHG-4080-1200	AHG-40100-1200
1500	AHG-2545-1500	AHG-4080-1500	AHG-40100-1500

Please refer to [page 37](#) for Accessories

### Specifications & Dimensions

Power (Watts)	Dimension Size (L x B x H)(mm)	Frequency Control	Power Intensity Control	Sweeping Function	Remote Contact / Voltage Control	Temp Control	Power Supply
300	355 x 395 x 145	Micro Processor Based	Yes	Yes	Yes	No	230 V 1 Phase
600							
1000							
1200							
1500							

**Model Format :**                      AHG-33300-H  
     AHG-FFPPPP-H

**AHG – Alstron Ultrasonic Generator**  
**FF – Frequency (28, 33, 40 KHz)**                      **PPPP – Ultrasonic Power Rating**  
**H – Temperature Control**

## SY-ART SERIES - INDUSTRIAL APPLICATION ULTRASONIC CLEANER

### ARC Recirculation Tank

#### Recirculation Tank with Oil Separator

- ✓ Standalone Ultrasonic Cleaner with Recirculation system
- ✓ Includes heater & Automatic Valve Control
- ✓ Chemical Pump with filter
- ✓ PLC Control with HMI Control
- ✓ SS316 Construction for wetted parts
- ✓ SS304 Structure & External Cover

33 kHz

Power (Watts)	Volume (Litres)	33 kHz Model
1000	45	ARC-331000-50H-RCS
1500	90	ARS-331500-90H-RCS
2400	192	ARS-332400-192H-RCS

Please refer to [page 37](#) for Accessories

#### Inner Tank Specifications & Dimensions

Power (Watts)	Volume (Litres)	Inner Tank Size (L x B x H)(mm)	Recirculation Pump	Oil Separator	Heating Power (W)	Power Supply
1000	45	500 x 300 x 300	Yes	Yes	1200	230 V 1 Phase
1500	90	600 x 500 x 300			2000	415 V 3 Phase
2400	192	800 x 600 x 400			4000	

Option for other frequency available upon request



## SY-ART SERIES - INDUSTRIAL APPLICATION ULTRASONIC CLEANER

### ARS Rinsing Tank

#### Standalone Rinsing Tank with Recirculation Filter, Heater & Hand Spray

- ✓ Rinsing Station after Cleaning process
- ✓ Save Water by recirculation water use for initial Rinse
- ✓ Final Rinse with fresh rinse from hand spray, over-flow water are automatically drained
- ✓ SS316 Construction for wetted parts

Heating Power (Watts)	Volume (Litres)	Model
1200	50	ARS-800-50H-RC
1500	72	ARS-1200-72H-RC
2000	175	ARS-2000-175H-RC

Please refer to [page 32](#) for Accessories

#### Inner & Outer Tank Specifications & Dimensions

Heating Power (Watts)	Volume (Litres)	Inner Tank Size (L x B x H)(mm)	Filter Element & Pump	Inlet & Outlet	Overflow	Hand Spray	Available For ALT/AST Models
1200	50	450 x 450 x 250	Yes	1/2 inch & 1 inch	Yes	Yes	ALT-XX800 AST-XX800
1500	72	600 x 400 x 300		1/2 inch & 1 1/4 inch			ALT-XX1200 AST-XX1200
2000	175	700 x 500 x 500		1/2 inch & 1 1/4 inch			ALT-XX2000 AST-XX1200

# SY-ART SERIES - INDUSTRIAL APPLICATION ULTRASONIC CLEANER

## Ultrasonic Power Meter

### Ultrasonic Power Measuring Tool

- ✓ Consistency of power in the cleaning tank for quality cleaning process over a duration
- ✓ Measuring energy variations with different cleaning liquids and temperature
- ✓ Comparing the power output of different tank of similar capacity
- ✓ Checking ageing transducers in the cleaning system
- ✓ Mapping of power intensity in different depths of the tank for best cleaning results
- ✓ Inspection of actual cavitation in cleaning tank so as to cater for periodic maintenance and calibration.



Model	UM-DBS-200S	UM-DBS-1000
Measuring span	0 - 255 w/in <sup>2</sup>	0 - 255 w/in <sup>2</sup>
Measuring frequency	10 kHz – 200 kHz	10 kHz – 1 MHz
Data display	Color screen, Time and Energy curve, maximum and average minimum, record files	Color screen, Time and Energy curve, maximum and average minimum, record files
Data storage	Time, Instant Energy, Continuous record 48 hours, 360k point data (0.5 seconds/point)	Time, Instant Energy, Continuous record 48 hours, 360k point data (0.5 seconds/point)
Power supply	Rechargeable battery 3.7 v	Rechargeable battery 3.7 v
Probe Operating Temperature	0 - 150 °C	0 - 150 °C
Probe Material	Stainless steel	Stainless steel
Probe Diameter	25 mm	25 mm
Probe Length	1.0 m ; +0.5 m Cable	1.0 m ; +0.5 m Cable
Frequency display	Yes	Yes
Meter Dimensions (W x L x H)	205 x 100 x 35 mm	
Storage Box Dimensions (W x L x H)	590 x 830 x 95 mm (Including handles protrusion)	
Weight	2.7 kg	



Probe with Ultrasonic meter



Ultrasonic Meter Set with Storage Box



# SY-ART SERIES - INDUSTRIAL APPLICATION ULTRASONIC CLEANER

## Alstron Oven

- ✓ **Stable & Reliable**
- ✓ **Uniformity of Temperature within the oven**
- ✓ **Use of Sirocco Blower which provide greater air flow, preventing any dead zone within the oven**
- ✓ **Microprocessor-based Temperature Control**
- ✓ **PT100 Sensor**
- ✓ **Side Access Port for cables to enter chamber**
- ✓ **Temperature Range Up to 2000C.**  
(Option: High-3000C)
- ✓ **Independent Over Temperature Protection**
- ✓ **Optional: RS232/RS485 Output for Data logging**



Model	ALO-2000-91-1	ALO-2700-216-1	ALO-5800-324-3	ALO-6800-512-3	ALO-8000-1000-3
HMI	HMI-ALO-2000-91-1	HMI-ALO-2700-216-1	HMI-ALO-5800-324-3	HMI-ALO-6800-512-3	HMI-ALO-8000-1000-3
Power (KW)	2	2.7	5.8	6.8	8.0
Input Supply	1 Ph, 220 VAC 50 / 60 Hz	1 Ph, 220 VAC 50 / 60 Hz	3 Ph, 415 VAC 50 / 60 Hz	3 Ph, 415 VAC 50 / 60 Hz	3 Ph, 415 VAC 50 / 60 Hz
External Dimension (mm) (D x W x H)	775 x 620 x 1050	925 x 770 x 1200	925 x 770 x 1500	1143 x 1000 x 1400	1343 x 1200 x 1600
Internal Dimension (mm) (D x W x H)	450 x 450 x 450	600 x 600 x 600	600 x 600 x 900	800 x 800 x 800	1000 x 1000 x 1000
Volume (L)	91	216	324	512	1000
No. of Doors	1	1	1	2	2
Internal Construction	High-quality SUS304 stainless steel plate	High-quality SUS304 stainless steel plate	High-quality SUS304 stainless steel plate	High-quality SUS304 stainless steel plate	High-quality SUS304 stainless steel plate
No. of Racks	2	2	2	3	3
Insulation Material	Glass Fibre	Glass Fibre	Glass Fibre	Glass Fibre	Glass Fibre
Temp. Range	R.T + 20 °C ~ 200 °C	R.T + 20 °C ~ 200 °C	R.T + 20 °C ~ 200 °C	R.T + 20 °C ~ 200 °C	R.T + 20 °C ~ 200 °C
Temp. Fluctuation	≤100°C : ±0.2°C ≤200°C : ±0.4°C	≤100°C : ±0.2°C ≤200°C : ±0.4°C	≤100°C : ±0.2°C ≤200°C : ±0.4°C	≤100°C : ±0.2°C ≤200°C : ±0.4°C	≤100°C : ±0.2°C ≤200°C : ±0.4°C
Temp. Deviation	±2°C	±2°C	±2°C	±2°C	±2°C
Temp. Rise Time	≤ 40 min	≤ 40 min	≤ 40 min	≤ 40 min	≤ 60 min
Temp. Control	PT100	PT100	PT100	PT100	PT100
Temp. Control Type	Microprocessor PID control	Microprocessor PID control	Microprocessor PID control	Microprocessor PID control	Microprocessor PID control
Temp. Reset Method	Press UP/DN to set Value	Press UP/DN to set Value	Press UP/DN to set Value	Press UP/DN to set Value	Press UP/DN to set Value
Temp. Display	Measurement and set temperature LED digital display	Measurement and set temperature LED digital display	Measurement and set temperature LED digital display	Measurement and set temperature LED digital display	Measurement and set temperature LED digital display
Temp. Sensor	Industrial platinum resistance PT 100	Industrial platinum resistance PT 100	Industrial platinum resistance PT 100	Industrial platinum resistance PT 100	Industrial platinum resistance PT 100
OverTemp Protection	Yes	Yes	Yes	Yes	Yes
Temp Recorder	RS232	RS232	RS232	RS232	RS232

## SY-ART SERIES - INDUSTRIAL APPLICATION ULTRASONIC CLEANER

### Accessories – Support Base Table

#### Support Base Table for ALT & AST Cleaning Tank

- ✓ Standalone Table for Cleaning Tank
- ✓ SS304 construction
- ✓ Optional with castor wheel with brake



Model	Dimension Size (L x B x H)(mm)	Base Height (mm)	Castor Wheel
ABT-600-500B	450 x 450 x 550	100 (Adjustable)	No
ABT-800-500B	520 x 520 x 500	100 (Adjustable)	No
ABT-1200-470B	680 x 560 x 470	100 (Adjustable)	No
ABT-600-500CW	450 x 450 x 550	105	Yes
ABT-800-500BCW	520 x 520 x 500	105	Yes
ABT-1200-470BCW	680 x 560 x 470	105	Yes

#### Base Frame for ALT Tank

- ✓ Base support Frame for ALT Series
- ✓ Built in SS304 Material
- ✓ Rugged & Rigid
- ✓ Can be bolted down to the ground
- ✓ Use in Marine & on board ship



Model	Inner Tank Size (L x B x H)(mm)	Material	Compatible Models
ABS-1200-72-00	654 x 454 x 100	SS304	ALT-xx1200-72H
ABS-1200-82-00	640 x 556 x 100		ALT-xx1200-82H
ABS-1500-90-00	707 x 735 x 100		ALT-xx1500-90H
ABS-2000-140-00	805 x 807 x 100		ALT-xx2000-140H
ABS-2400-245-00	807 x 970 x 100		ALT-xx2400-245H
ABS-2750-420-00	1260 x 880 x 100		ALT-xx2750-420H
xx - All Frequency compatible			



# SY-ART SERIES - INDUSTRIAL APPLICATION ULTRASONIC CLEANER

## Accessories - Glasses

### Borosilicate Glasses Container & Beaker

- ✓ For holding solvent, aggressive Liquid and delicate parts during cleaning
- ✓ Suitable for use when using aggressive liquid inside Ultrasonic cleaning Tank filled with water



Model	Volume (ml)	Outer Diameter (mm)	Thickness (mm)	Height (mm)
ABG-0060-95	600	95	2.1	130
ABG-0100-113	1000	113	2.2	155
ABG-0300-163	3000	163	2.5	215
ABG-0500-186	5000	186	2.5	272
ABG-1000-237	10000	237	3	355
ABG-2500-200	25000	400	6	200

Available in Quartz Glass for custom order



Borosilicate Glass Beaker

# SY-ART SERIES - INDUSTRIAL APPLICATION ULTRASONIC CLEANER

## Accessories - Time Based Water Inlet

### Time Based Water Inlet

- ✓ Common Fit for All ALT & AST Tank with water Inlet
- ✓ Adjustable Manual Timer
- ✓ Solenoid Valve Control
- ✓ Additional Manual Water Top Up Button



Model	Port Size	Valve Type	Timer	Manual Fill	Power Supply
ATI-0500-SS-MT	1/2 Inch	Solenoid Valve	10 sec – 99 min	Yes	AC 230 V, 1 Phase
ATI-0750-SS-MT	3/4 inch				
SS - SS304 MT - Manual Time					



# SY-ART SERIES - INDUSTRIAL APPLICATION ULTRASONIC CLEANER

## Accessories - Recirculation Filter Module

### Recirculation Filter Module

- ✓ Standalone Filter Module unit with Recirculation Pump
- ✓ For Oil & grease interceptor
- ✓ For Oil & water separators
- ✓ Comes with Filter cartridge for particle removal
- ✓ Works with Alstron Standalone Cleaning System

Model	Max Volume (Litres)	Inner Tank Size (L x B x H)(mm)	Oil Separator	Filter	Castor Wheel	Power Supply
ARM-1200-RCS	25	500 x 300 x 500	Yes	Yes	Yes	230 V 1 Phase
ARM-2750-RCS	90	600 x 450 x 700				

**SY-ART SERIES - INDUSTRIAL APPLICATION ULTRASONIC CLEANER**

**Cleaning Chemicals**

**Non-Toxic Environmentally Friendly Degreaser / Cleaner – ALSOLZ-801**

- ✓ Bio Degradable
- ✓ Non-Toxic
- ✓ Non Corrosive
- ✓ Non-Hazardous
- ✓ PH 9 – 9.8



Chemical ALSOLZ-801 Model	Volume (ml)	PH Level	Purpose & Usage	Flammability	Specific Gravity	Appearance	Odor	Solubility
ALSOLZ-801-005	500	9.0 - 9.8	Degreasing and general cleaning	Non-Flammable	0.99 - 1.00	water like liquid	Citrus	100%
ALSOLZ-801-010	1000							



# SY-ART SERIES - INDUSTRIAL APPLICATION ULTRASONIC CLEANER

## Accessories

Portable Heater Model	Power (Watts)	Hot Zone (mm)	Material	Overheat Protection	Temp Range	Power Supply	Size (mm)
APH-1200-1	1500	80	SS316	Yes	20 - 80 °C	230 Vac 1 phase	450 x 150 (H x L)
APH-2000-1	2000						500 x 200 (H x L)

Silicon Heater	Model	Power (Watts)	Hot Zone (mm)	Material	Overheat Protection	Temp Range	Power Supply	Size (mm)
	HT-SC300W-250-80	300	NA	Silicon	No	Up to 70 °C	230 Vac 1 phase	250 x 80 (L x W)
	HT-SC600W-380-80	600						380 x 80 (L x W)



Immersion Heater	Immersion Heater Model	Power (Watts)	Immersion Length (mm)	Temp Range	Power Supply	Connection Size
	HT-1P1200W-1NPT	1200	280	Up to 100 °C	230 VAC 1 phase	1 inch NPT
	HT-1P2000W-1NPT	2000	420			
	HT-3P4000W-2NPT	4000	500		415 V 3 Phase	2 inch NPT
	HT-3P6000W-2NPT	6000	550			

PT100 Sensor	PT100 Sensor Model	Sensor Type	Diameter Size (mm)	Length (mm)	Measuring Range	Accuracy	Mounting
	TS-DCPT-20-4	Pt100	20 (Dia) x 4 mm	2 meter	Up to 500 Degree C	0.1 degree	Epoxy
	TS-IMPT-50-025NPT-C2M		50 (length) x 6 mm (Dia)				1/4inch NPT
	TS-IMPT-50-025NPT-MH			none			1/4inch NPT w Mushroom Head

Dual Display Temperature Controller	Model	Sensor Type	Sampling Cycle (ms)	Alarm Output	Size (mm)	Power Supply
	TC-TZN4S-14S	Thermocouple, PT100	500	SSR x 1	48 x 48	100 - 230 V 1 Phase



## SY-ART SERIES - INDUSTRIAL APPLICATION ULTRASONIC CLEANER

### Accessories

Solid State Relay	Model	Rated Load Current	Load Voltage	Trigger Voltage	Response Time
	SSR-25DA	25A	24-380Vac, 1 Phase	3-32Vdc	10ms
	ESR-25DA	25A	24-420Vac, 3Phase	3-32Vdc	8ms

Solenoid Valve	Model	Material	Size (BSP)	Pressure (Bar)	Seal	Power Supply
	A-DN15-24V	SS316	1/2 inch	0 - 5	Viton	DC 24 V
	A-DN20-24V		3/4 inch			
	A-DN25-24V		1 inch			
	A-DN32-24V		1 1/4 inch			
	A-DN40-24V		1 1/2 inch			
	A-DN50-24V		2 inch			

Manual Valve	Model	Material	Size (BSP)	Pressure (Bar)	Seal	Max Temp.
	MV-0500-SSB	SS316	1/2 inch	68	PTFE	0 - 180 °C
	MV-0750-SSB		3/4 inch			
	MV-1000-SSB		1 inch			
	MV-1250-SSB		1 1/4 inch			
	MV-1500-SSB		1 1/2 inch			
	MV-2000-SSB		2 inch			

Filter Housing	Model	Material	Port Size	Length	Temp Range
	A-PSH102	PP	1/2 inch	10 inch	60 °C
	AFH-250-0500-S-00	SS304	1/2 inch	10 inch	120 °C

Vertical Float Switch	Model	Material	Stem	Seal	Size (Dia x H)(mm)	Max Current (A)
	FS-1245S	SS316	M10	Viton	28 x 28	0.7
	FS-1642PVDF	PVDF	1/8 NPT		25 x 25	



# SY-ART SERIES - INDUSTRIAL APPLICATION ULTRASONIC CLEANER

## Customised Ultrasonic Cleaner

Professionally conceptualise, design and fabricate to customer's special cleaning process requirements.



Recirculation Ultrasonic Cleaning System with Servo Litter and Basket Oscillation



Dual 40/80kHz Frequency Ultrasonic Cleaning System



Separate Tank Dual Generator Cleaning System



Customised Alstron 28 kHz 4500 watts Ultrasonic Cleaning System with Immersion Heater and Gas spring Top cover



## SYNERGY INFRASTRUCTURE







# SYNERGY

INNOVATIVE DIVING EQUIPMENT TRADING LLC

INSPIRING • ENGINEERING • INNOVATION

UAE • UK • INDIA • AZERBAIJAN



## SY- ART SERIES - INDUSTRIAL APPLICATION ULTRASONIC CLEANER

### Contact us

29th Street, Amman Road, Behind Al Huraiz Est. For Industry,  
Al Qusais, Industrial Area - 1,  
Dubai, United Arab Emirates

- Tel : 009714 2580533
- Fax : 009714 2580534
- UAE : 00971505648178
- UK : 00447951966260

- Website : [www.synergiequipment.com](http://www.synergiequipment.com)
- Email : [ram@synergiequipment.com](mailto:ram@synergiequipment.com)
- For Sale : [info@synergiequipment.com](mailto:info@synergiequipment.com)

